



# Parker Industrial Hose

Catalog 4800 July 2018



ENGINEERING YOUR SUCCESS.

**Couplings & Equipment**



# Couplings & Equipment Selector Guide

Series	Hose Application / Construction		Size Range (in)	Page No.
660-T	Ferrule vise crimper, manual	1" ID hose capacity	1	280
670-T	Ferrule vise crimper, air powered	1" ID hose capacity	1	280
7610/CS	Crimp coupling, steam	Female Ground Joint NPSM with Wing Nut and O-Ring	3/4 - 1	271
7612	Spud adapter, steam	3/4" Female Pipe Straight x 1-1/2" Ground Joint Male		271
7661/LA-FJ	Crimp coupling	Female JIC 37° – Straight Swivel	2	269
7661/LA-NP	Crimp coupling	Male NPTF Pipe – Straight Rigid	2	270
7661/LAR-FJ	Crimp coupling	Female JIC 37° – Straight Swivel with Internal O-Ring	1	270
7661/LAR-MP	Crimp coupling	Male NPTF Pipe – Straight Rigid with Internal O-Ring	1	270
7661/TY-FA	Crimp coupling	Female SAE 45° – Straight Swivel	1/4 - 5/8	268
7661/TY-FF	Crimp coupling	Female NPTF Pipe – Straight Rigid	1/4	268
7661/TY-FJ	Crimp coupling	Female JIC 37° – Straight Swivel	1/4 - 1/2	268
7661/TY-MP	Crimp coupling	Male NPTF Pipe – Straight Rigid	1/4 - 1/2	269
7661/TY-SP	Crimp coupling	Male NPTF Pipe – Straight Swivel	1/2	269
CGHBL	Brass stem	Welding connection	3/4	272
COS-K1	Adjustable crimper	1-1/4" ID hose capacity	1-1/4	274
COS-K2	Adjustable crimper	2" ID hose capacity	2	275
COS-K4	Adjustable crimper	4" ID hose capacity	4	276
COS-K6	Adjustable crimper	6" ID hose capacity	6	278
COS-10	Adjustable crimper	10" ID hose capacity	10	279
HBL-C	Crimp coupling stem, DEF	Male BSPP w/Seal – Straight Rigid (SS)	3/4	272
HBL-C	Crimp coupling stem, DEF	Male NPTF Pipe – Straight Rigid (SS)	3/4	273
S10143	Crimp coupling	Male NPTF Pipe – Straight Rigid	1/4 - 2	265
S10171	Crimp coupling	Male NPTF Pipe – Straight Rigid	1-1/4 - 2	266
S101CC	Crimp coupling	Male NPTF Pipe – Straight Rigid	1 - 2	266
S101CS	Crimp coupling	Male NPTF Pipe – Straight Rigid	3/4 - 1	271
S101HY	Crimp coupling	Male NPTF Pipe – Straight Rigid	1/4 - 1-1/4	261
S101WC	Crimp coupling	Male NPTF Pipe – Straight Rigid	2	267
S102HY	Crimp coupling	Female NPTF Pipe – Straight Rigid	1/4 - 1	262
S103HY	Crimp coupling	Male JIC 37° – Straight Rigid	1/4 - 1	262
S10643	Crimp coupling	Female JIC 37° – Straight Swivel	1/4 - 2	265
S106HY	Crimp coupling	Female JIC 37° – Straight Swivel	1/4 - 1-1/4	263
S106WC	Crimp coupling	Female JIC 37° – Straight Swivel	2	267
S107HY	Crimp coupling	Female NPSM Pipe – Straight Swivel	1/4 - 1/2	263
S11343	Crimp coupling	Male NPTF Pipe – Straight Swivel	1/4 - 1/2	266
S113HY	Crimp coupling	Male NPTF Pipe – Straight Swivel	1/4 - 1	264
S139HY	Crimp coupling	Female JIC 37° – 90° Swivel Short Drop Elbow	1/4 - 1	264
S1APWC	Crimp coupling, oilfield	Male API – Straight Rigid	2	267
S20820	Reattachable coupling	Female SAE 45° – Straight Swivel	5/16	272
SMCP	Crimp ferrules, DEF	Nickel-Plated Brass	3/4	273

The above table is a guide only. It is the responsibility of the end user to select and/or test the most appropriate product for the application. For more specific Industry Standards information, refer to the "Industry Standards" section of each respective product page. Contact Parker for additional information.

**A complete listing of industry standards is available in the Introduction section.**

**See the pages immediately following the Table of Contents for a complete index by series, and by product application and name.**





**⚠ WARNING:** This product can expose you to chemicals including Lead, which is known to the State of California to cause cancer and birth defects or other reproductive harm. For more information go to [www.p65warnings.ca.gov](http://www.p65warnings.ca.gov).

Due to continual product improvements, Parker reserves the right to alter specifications without prior notice.

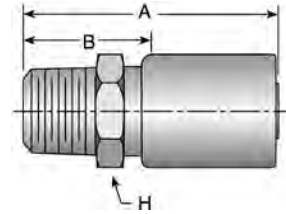
# Series HY

## S101HY Male NPTF Pipe – Straight Rigid



# Part Number	 Hose ID (in)	 Thread ID (in)	Thread Dash Size	Dimensions					 Approx Wt Per Ctn (lbs)	 Std Pack Qty (per carton)	 Pkg Type
				A (in)	A (mm)	H (in)	B (in)	B (mm)			
S101HY-2-4	1/4	1/8x27	-2	2.34	59	5/8	1.00	25	1.94	20	Carton
S101HY-4-4	1/4	1/4x18	-4	2.53	64	9/16	1.19	30	2.73	25	Carton
S101HY-4-6	3/8	1/4x18	-4	2.55	65	11/16	1.19	30	3.06	20	Carton
S101HY-6-4	1/4	3/8x18	-6	2.53	64	3/4	1.19	30	2.68	20	Carton
S101HY-6-6	3/8	3/8x18	-6	2.55	65	3/4	1.19	30	4.20	25	Carton
S101HY-6-8	1/2	3/8x18	-6	2.72	69	7/8	1.38	35	4.54	20	Carton
S101HY-8-6	3/8	1/2x14	-8	2.73	69	7/8	1.38	35	4.36	20	Carton
S101HY-8-8	1/2	1/2x14	-8	2.91	74	7/8	1.41	40	6.53	25	Carton
S101HY-8-10	5/8	1/2x14	-8	2.94	75	1-1/8	1.59	40	7.26	20	Carton
S101HY-8-12	3/4	1/2x14	-8	3.08	78	1-1/4	1.50	38	4.33	10	Carton
S101HY-12-8	1/2	3/4x14	-12	2.91	74	1-1/16	1.56	40	7.60	20	Carton
S101HY-12-10	5/8	3/4x14	-12	2.98	76	1-1/8	1.59	40	3.80	10	Carton
S101HY-12-12	3/4	3/4x14	-12	3.08	78	1-1/4	1.50	38	4.58	10	Carton
S101HY-12-16	1	3/4x14	-12	3.23	82	1-3/8	1.63	41	5.40	10	Carton
S101HY-16-12	3/4	1x11-1/2	-16	3.27	83	1-3/8	1.69	43	5.10	10	Carton
S101HY-16-16	1	1x11-1/2	-16	3.42	87	1-3/8	1.81	46	6.29	10	Carton
S101HY-20-20	1-1/4	1-1/4 x 11-1/2	-20	3.84	98	1-3/4	2.00	51	6.62	4	Carton

**WARNING:** This product can expose you to chemicals including Lead, which is known to the State of California to cause cancer and birth defects or other reproductive harm. For more information go to [www.p65warnings.ca.gov](http://www.p65warnings.ca.gov).





### Crimp Specifications

For currently qualified crimp specifications including coupling designation, refer to CrimpSource at [www.parker.com/crimpsource](http://www.parker.com/crimpsource). Refer to the COS-K4 crimper for crimp specs for hose 4" ID and smaller. Refer to the COS-K6 or COS-K10 crimpers for hose IDs larger than 4".

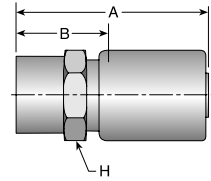
# Series HY

## S102HY Female NPTF Pipe – Straight Rigid







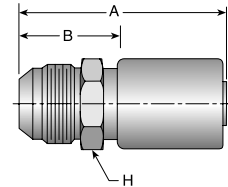

# Part Number	 Hose ID (in)	 Thread ID (in)	Thread Dash Size	Dimensions					 Approx Wt Per Ctn (lbs)	 Std Pack Qty (per carton)	 Pkg Type
				A (in)	A (mm)	H (in)	B (in)	B (mm)			
S102HY-2-4	1/4	1/8x27	-2	2.34	59	5/8	1.00	25	2.24	20	Carton
S102HY-4-4	1/4	1/4x18	-4	2.47	63	11/16	1.13	29	3.23	25	Carton
S102HY-4-6	3/8	1/4x18	-4	2.48	63	11/16	1.13	29	2.94	20	Carton
S102HY-6-4	1/4	3/8x18	-6	2.47	63	7/8	1.13	29	2.94	20	Carton
S102HY-6-6	3/8	3/8x18	-6	2.48	63	7/8	1.13	29	4.58	25	Carton
S102HY-8-6	3/8	1/2x14	-8	2.75	70	1	1.41	36	5.53	25	Carton
S102HY-8-8	1/2	1/2x14	-8	2.84	72	1	1.50	38	6.98	25	Carton
S102HY-12-12	3/4	3/4x14	-12	2.83	72	1-1/4	1.25	32	4.05	10	Carton
S102HY-16-16	1	1x11-1/2	-16	3.27	83	1-1/2	1.66	42	6.18	10	Carton

**WARNING:** This product can expose you to chemicals including Lead, which is known to the State of California to cause cancer and birth defects or other reproductive harm. For more information go to [www.p65warnings.ca.gov](http://www.p65warnings.ca.gov).

# Series HY

## S103HY Male JIC 37° – Straight Rigid



# Part Number	 Hose ID (in)	 Thread ID (in)	Thread Dash Size	Dimensions					 Approx Wt Per Ctn (lbs)	 Std Pack Qty (per carton)	 Pkg Type
				A (in)	A (mm)	H (in)	B (in)	B (mm)			
S103HY-4-4	1/4	7/16x20	-4	2.52	64	5/8	1.19	30	2.75	25	Carton
S103HY-6-4	1/4	9/16x18	-6	2.53	64	11/16	1.19	30	2.68	20	Carton
S103HY-6-6	3/8	9/16x18	-6	2.54	65	11/16	1.19	30	3.80	25	Carton
S103HY-6-8	1/2	9/16x18	-6	2.72	69	7/8	1.38	35	5.50	25	Carton
S103HY-8-6	3/8	3/4x16	-8	2.64	67	13/16	1.28	33	3.96	20	Carton
S103HY-8-8	1/2	3/4x16	-8	2.81	71	5/8	1.47	37	6.10	25	Carton
S103HY-10-8	1/2	7/8x14	-10	2.91	74	1	1.56	40	5.60	20	Carton
S103HY-10-10	5/8	7/8x14	-10	2.98	76	1-1/8	1.59	40	9.08	25	Carton
S103HY-10-12	3/4	7/8x14	-10	3.08	78	1-1/4	1.50	38	2.23	5	Carton
S103HY-12-8	1/2	1-1/16x12	-12	3.02	77	1-1/8	1.66	42	8.98	25	Carton
S103HY-12-10	5/8	1-1/16x12	-12	3.09	78	1-1/8	1.72	44	9.65	25	Carton
S103HY-12-12	3/4	1-1/16x12	-12	3.19	81	1-1/4	1.63	41	4.60	10	Carton
S103HY-16-12	3/4	1-5/16x12	-16	3.23	82	1-3/8	1.66	42	5.29	10	Carton
S103HY-16-16	1	1-5/16x12	-16	3.39	86	1-3/8	1.78	45	6.44	10	Carton

**WARNING:** This product can expose you to chemicals including Lead, which is known to the State of California to cause cancer and birth defects or other reproductive harm. For more information go to [www.p65warnings.ca.gov](http://www.p65warnings.ca.gov).



### Crimp Specifications

For currently qualified crimp specifications including coupling designation, refer to CrimpSource at [www.parker.com/crimpsource](http://www.parker.com/crimpsource). Refer to the COS-K4 crimper for crimp specs for hose 4" ID and smaller. Refer to the COS-K6 or COS-K10 crimpers for hose IDs larger than 4".

# Series HY

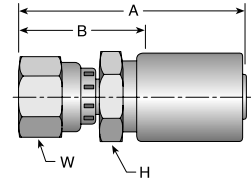
## S106HY Female JIC 37° – Straight Swivel







# Part Number			Thread Dash Size	Dimensions						Approx Wt Per Ctn (lbs)	Std Pack Qty (per carton)	
				A (in)	A (mm)	H (in)	W (in)	B (in)	B (mm)			
S106HY-4-4	1/4	7/16x20	-4	2.60	66	9/16	9/16	1.25	32	3.18	25	Carton
S106HY-4-6	3/8	7/16x20	-4	2.67	68	3/4	9/16	1.31	33	3.30	20	Carton
S106HY-5-4	1/4	1/2x20	-5	2.65	67	9/16	5/8	1.31	33	2.52	20	Carton
S106HY-6-4	1/4	9/16x18	-6	2.67	68	5/8	11/16	1.31	33	2.62	20	Carton
S106HY-6-6	3/8	9/16x18	-6	2.69	68	11/16	11/16	1.34	34	8.35	50	Carton
S106HY-6-8	1/2	9/16x18	-6	2.86	73	7/8	9/16	1.50	38	4.80	20	Carton
S106HY-8-6	3/8	3/4x16	-8	2.72	69	7/8	7/8	1.38	35	3.96	20	Carton
S106HY-8-8	1/2	3/4x16	-8	2.90	74	7/8	7/8	1.56	40	13.20	50	Carton
S106HY-8-10	5/8	3/4x16	-8	2.98	76	1-1/8	7/8	1.59	40	7.06	20	Carton
S106HY-8-12	3/4	3/4x16	-8	3.08	78	1-1/4	7/8	1.53	39	2.64	10	Carton
S106HY-10-8	1/2	7/8x14	-10	2.98	76	1	1	1.63	41	6.20	20	Carton
S106HY-10-10	5/8	7/8x14	-10	3.06	78	1-1/8	1	1.69	43	9.95	25	Carton
S106HY-10-12	3/4	7/8x14	-10	3.16	80	1-1/4	1	1.59	40	5.23	10	Carton
S106HY-12-8	1/2	1-1/16x12	-12	3.05	77	1-1/8	1-1/4	1.69	43	3.84	10	Carton
S106HY-12-10	5/8	1-1/16x12	-12	3.12	79	1-1/8	1-1/4	1.75	44	4.48	10	Carton
S106HY-12-12	3/4	1-1/16x12	-12	3.22	82	1-1/4	1-1/4	1.66	42	13.08	25	Carton
S106HY-12-16	1	1-1/16x12	-12	3.38	86	1-3/8	1-1/4	1.75	44	6.40	10	Carton
S106HY-16-16	1	1-5/16x12	-16	3.45	88	1-3/8	1-1/2	1.84	47	6.86	10	Carton
S106HY-20-20	1-1/4	1-5/8x12	-20	4.09	104	2	2	2.25	57	5.00	4	Carton

**WARNING:** This product can expose you to chemicals including Lead, which is known to the State of California to cause cancer and birth defects or other reproductive harm. For more information go to [www.p65warnings.ca.gov](http://www.p65warnings.ca.gov).

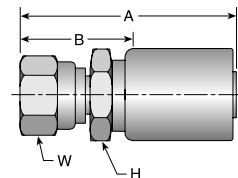
# Series HY

## S107HY Female NPSM Pipe – Straight Swivel



# Part Number			Thread Dash Size	Dimensions						Approx Wt Per Ctn (lbs)	Std Pack Qty (per carton)	
				A (in)	A (mm)	H (in)	W (in)	B (in)	B (mm)			
S107HY-4-4	1/4	1/4x18	-4	2.66	68	9/16	11/16	1.31	33	2.76	20	Carton
S107HY-6-6	3/8	3/8x18	-6	2.55	65	3/4	7/8	1.19	30	5.25	25	Carton
S107HY-8-8	1/2	1/2x14	-8	2.91	74	3/4	1	1.56	40	7.55	25	Carton

**WARNING:** This product can expose you to chemicals including Lead, which is known to the State of California to cause cancer and birth defects or other reproductive harm. For more information go to [www.p65warnings.ca.gov](http://www.p65warnings.ca.gov).

### Crimp Specifications

For currently qualified crimp specifications including coupling designation, refer to CrimpSource at [www.parker.com/crimpsource](http://www.parker.com/crimpsource). Refer to the COS-K4 crimper for crimp specs for hose 4" ID and smaller. Refer to the COS-K6 or COS-K10 crimpers for hose IDs larger than 4".

# Series HY

## S113HY Male NPTF Pipe – Straight Swivel

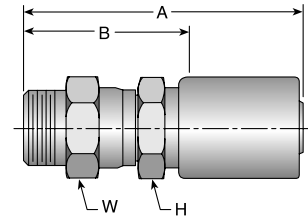

# Part Number	Hose ID (in)	Thread ID (in)	Thread Dash Size	Dimensions						Approx Wt Per Ctn (lbs)	Std Pack Qty (per carton)	Pkg Type
				A (in)	A (mm)	H (in)	W (in)	B (in)	B (mm)			
S113HY-4-4	1/4	1/4x18	-4	3.06	78	9/16	5/8	1.72	44	2.95	25	Carton
S113HY-6-6	3/8	3/8x18	-6	3.11	79	11/16	11/16	1.75	44	6.23	25	Carton
S113HY-8-8	1/2	1/2x14	-8	3.50	89	7/8	7/8	2.16	55	8.55	25	Carton
S113HY-12-12	3/4	3/4x14	-12	3.95	100	1-1/4	1-1/4	2.38	60	7.50	10	Carton
S113HY-16-16	1	1x11-1/2	-16	4.23	107	1-1/2	1-1/2	2.63	67	11.52	10	Carton

**Material:** Plated steel

**WARNING:** This product can expose you to chemicals including Lead, which is known to the State of California to cause cancer and birth defects or other reproductive harm. For more information go to [www.p65warnings.ca.gov](http://www.p65warnings.ca.gov).

# Series HY

## S139HY Female JIC 37° – 90° Swivel Short Drop Elbow

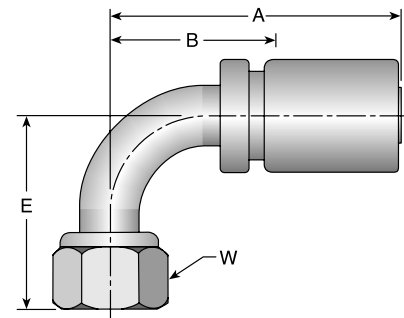

# Part Number	Hose ID (in)	Thread ID (in)	Thread Dash Size	Dimensions						Approx Wt Per Ctn (lbs)	Std Pack Qty (per carton)	Pkg Type	
				A (in)	A (mm)	E (in)	E (mm)	W (in)	B (in)				B (mm)
S139HY-4-4	1/4	7/16x20	-4	2.40	61	0.83	21	9/16	1.13	29	1.47	10	Carton
S139HY-6-4	1/4	9/16x18	-6	2.65	67	0.91	23	3/4	1.38	35	1.63	10	Carton
S139HY-6-6	3/8	9/16x18	-6	2.57	65	0.91	23	11/16	1.29	33	2.17	10	Carton
S139HY-8-6	3/8	3/4x16	-8	2.64	67	1.14	29	7/8	1.37	35	2.70	10	Carton
S139HY-8-8	1/2	3/4x16	-8	2.85	72	1.14	29	7/8	1.56	40	3.60	10	Carton
S139HY-10-8	1/2	7/8x14	-10	3.01	76	1.26	32	1	1.72	44	3.72	10	Carton
S139HY-10-10	5/8	7/8x14	-10	3.09	78	1.26	32	1	1.73	44	4.73	10	Carton
S139HY-12-8	1/2	1-1/16x12	-12	3.61	92	1.83	46	1-1/4	2.25	57	7.00	10	Carton
S139HY-12-10	5/8	1-1/16x12	-12	3.61	92	1.89	48	1-1/4	2.25	57	7.00	10	Carton
S139HY-12-12	3/4	1-1/16x12	-12	3.68	93	1.89	48	1-1/4	2.15	55	3.50	5	Carton
S139HY-16-12	3/4	1-5/16x12	-16	4.33	110	2.14	54	1-1/2	2.78	71	4.30	5	Carton
S139HY-16-16	1	1-5/16x12	-16	4.31	109	2.31	59	1-1/2	2.69	68	4.78	5	Carton

**Material:** Plated steel

**WARNING:** This product can expose you to chemicals including Lead, which is known to the State of California to cause cancer and birth defects or other reproductive harm. For more information go to [www.p65warnings.ca.gov](http://www.p65warnings.ca.gov).

### Crimp Specifications

For currently qualified crimp specifications including coupling designation, refer to CrimpSource at [www.parker.com/crimpsource](http://www.parker.com/crimpsource). Refer to the COS-K4 crimper for crimp specs for hose 4" ID and smaller. Refer to the COS-K6 or COS-K10 crimpers for hose IDs larger than 4".

## Series 43

### S10143 Male NPTF Pipe – Straight Rigid

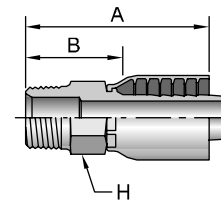

# Part Number	Hose ID (in)	Thread ID (in)	Thread Dash Size	Dimensions					Approx Wt Per Ctn (lbs)	Std Pack Qty (per carton)	Pkg Type
				A (in)	A (mm)	H (in)	B (in)	B (mm)			
S10143-4-4	1/4	1/4x18	-4	2.01	51	9/16	1.26	32	3.00	25	Carton
S10143-6-6	3/8	3/8x18	-6	2.37	60	3/4	1.34	34	4.25	25	Carton
S10143-8-8	1/2	1/2x14	-8	2.84	72	7/8	1.58	40	5.30	20	Carton
S10143-12-12	3/4	3/4x14	-12	3.09	78	1-1/16	1.65	42	4.35	10	Carton
S10143-16-16	1	1x11-1/2	-16	2.59	66	1-3/8	1.97	50	3.71	5	Carton
S10143-20-20	1-1/4	1-1/4x11-1/2	-20	4.08	104	1-3/4	2.39	61	5.50	5	Carton
S10143-24-24	1-1/2	1-1/2x11-1/2	-24	3.50	89	2	2.13	54	8.06	5	Carton
S10143-32-32	2	2x11-1/2	-32	4.05	103	2-1/2	2.27	58	13.37	5	Carton

**Material:** Plated steel

**WARNING:** This product can expose you to chemicals including Lead, which is known to the State of California to cause cancer and birth defects or other reproductive harm. For more information go to [www.p65warnings.ca.gov](http://www.p65warnings.ca.gov).

## Series 43

### S10643 Female JIC 37° – Straight Swivel

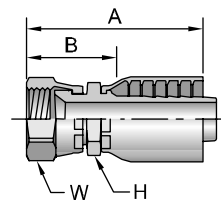

# Part Number	Hose ID (in)	Thread ID (in)	Thread Dash Size	Dimensions					Approx Wt Per Ctn (lbs)	Std Pack Qty (per carton)	Pkg Type	
				A (in)	A (mm)	H (in)	W (in)	B (in)				B (mm)
S10643-4-4	1/4	7/16x20	-4	1.94	49	9/16	9/16	1.19	30	2.63	25	Carton
S10643-6-6	3/8	9/16x18	-6	2.29	58	11/16	11/16	1.26	32	4.33	25	Carton
S10643-8-8	1/2	3/4x16	-8	2.63	67	13/16	7/8	1.37	35	5.14	20	Carton
S10643-12-12	3/4	1-1/16x12	-12	3.17	81	1-1/16	1-1/4	1.73	44	2.35	5	Carton
S10643-16-16	1	1-5/16x12	-16	3.62	92	1-3/8	1-1/2	2.00	51	4.15	5	Carton
S10643-20-20	1-1/4	1-5/8x12	-20	3.94	100	1-7/8	2	2.25	57	7.60	5	Carton
S10643-24-24	1-1/2	1-7/8x12	-24	3.84	98	2-1/8	2-1/4	2.47	63	4.00	2	Carton
S10643-32-32	2	2-1/2x12	-32	4.73	120	2-1/2	2-7/8	2.95	75	3.08	1	Carton

**Material:** Plated steel

**WARNING:** This product can expose you to chemicals including Lead, which is known to the State of California to cause cancer and birth defects or other reproductive harm. For more information go to [www.p65warnings.ca.gov](http://www.p65warnings.ca.gov).

#### Crimp Specifications





For currently qualified crimp specifications including coupling designation, refer to CrimpSource at [www.parker.com/crimpsource](http://www.parker.com/crimpsource). Refer to the COS-K4 crimper for crimp specs for hose 4" ID and smaller. Refer to the COS-K6 or COS-K10 crimpers for hose IDs larger than 4".

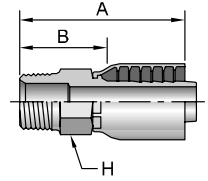

## Series 43

### S11343 Male NPTF Pipe – Straight Swivel



# Part Number	 Hose ID (in)	 Thread ID (in)	Thread Dash Size	Dimensions					 Approx Wt Per Ctn (lbs)	 Std Pack Qty (per carton)	 Pkg Type
				A (in)	A (mm)	H (in)	B (in)	B (mm)			
S11343-4-4	1/4	1/4X18	-4	2.68	68	5/8	1.93	49	1.53	10	Carton
S11343-6-6	3/8	3/8X18	-6	3.08	78	3/4	2.05	52	2.55	10	Carton
S11343-8-8	1/2	1/2X14	-8	3.52	89	7/8	2.26	57	3.70	10	Carton





**Material:** Plated steel

**WARNING:** This product can expose you to chemicals including Lead, which is known to the State of California to cause cancer and birth defects or other reproductive harm. For more information go to [www.p65warnings.ca.gov](http://www.p65warnings.ca.gov).

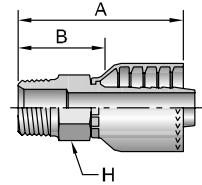
## Series 71

### S10171 Male NPTF Pipe – Straight Rigid



# Part Number	 Hose ID (in)	 Thread ID (in)	Thread Dash Size	Dimensions					 Approx Wt Per Ctn (lbs)	 Std Pack Qty (per carton)	 Pkg Type
				A (in)	A (mm)	H (in)	B (in)	B (mm)			
S10171-20-20	1-1/4	1-1/4x11-1/2	-20	4.06	103	1-3/4	2.39	61	2.50	2	Carton
S10171-24-24	1-1/2	1-1/2x11-1/2	-24	4.32	110	2	2.19	56	2.02	1	Carton
S10171-32-32	2	2x11-1/2	-32	4.66	118	2-1/2	2.52	64	6.45	2	Carton





**Material:** Plated steel

**WARNING:** This product can expose you to chemicals including Lead, which is known to the State of California to cause cancer and birth defects or other reproductive harm. For more information go to [www.p65warnings.ca.gov](http://www.p65warnings.ca.gov).

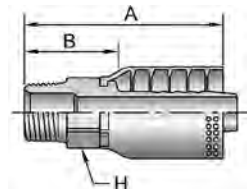
## Series CC

### S101CC Male NPTF Pipe – Straight Rigid



# Part Number	 Hose ID (in)	 Thread ID (in)	Thread Dash Size	Dimensions					 Approx Wt Per Ctn (lbs)	 Std Pack Qty (per carton)	 Pkg Type
				A (in)	A (mm)	H (in)	B (in)	B (mm)			
S101CC-16-16CW	1	1x11-1/2	-16	3.94	100	1-3/8	2.00	51	18.60	20	Carton
S101CC-20-20CW	1-1/4	1-1/4x11-1/2	-20	4.06	103	1-3/4	2.39	61	3.00	–	Carton
S101CC-24-24CW	1-1/2	1-1/2x11-1/2	-24	3.50	89	2	2.13	54	5.00	5	Carton
S101CC-32-32CW	2	2x11-1/2	-32	5.39	137	2-5/8	2.14	54	13.00	2	Carton

**Material:** Stainless Steel Inserts, Carbon Steel Ferrules

**WARNING:** This product can expose you to chemicals including Lead, which is known to the State of California to cause cancer and birth defects or other reproductive harm. For more information go to [www.p65warnings.ca.gov](http://www.p65warnings.ca.gov).

#### Crimp Specifications

For currently qualified crimp specifications including coupling designation, refer to CrimpSource at [www.parker.com/crimpsource](http://www.parker.com/crimpsource). Refer to the COS-K4 crimper for crimp specs for hose 4" ID and smaller. Refer to the COS-K6 or COS-K10 crimpers for hose IDs larger than 4".

## Series WC S1APWC Male API – Straight Rigid

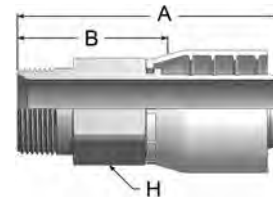

# Part Number	Hose ID (in)	Thread ID (in)	Thread Dash Size	Dimensions					Approx Wt Per Ctn (lbs)	Std Pack Qty (per carton)	Pkg Type
				A (in)	A (mm)	H (in)	B (in)	B (mm)			
S1APWC-32-32	2	2x11-1/2	-32	7.17	182	2-5/8	3.92	99	2.00	2	Carton

**Material:** Plated steel

**WARNING:** This product can expose you to chemicals including Lead, which is known to the State of California to cause cancer and birth defects or other reproductive harm. For more information go to [www.p65warnings.ca.gov](http://www.p65warnings.ca.gov).

## Series WC S101WC Male NPTF Pipe – Straight Rigid

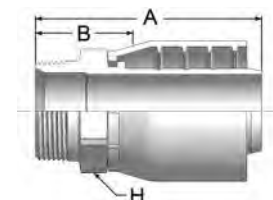

# Part Number	Hose ID (in)	Thread ID (in)	Thread Dash Size	Dimensions					Approx Wt Per Ctn (lbs)	Std Pack Qty (per carton)	Pkg Type
				A (in)	A (mm)	H (in)	B (in)	B (mm)			
S101WC-32-32	2	2x11-1/2	-32	5.39	137	2-5/8	2.14	54	2.00	2	Carton

**Material:** Plated steel

**WARNING:** This product can expose you to chemicals including Lead, which is known to the State of California to cause cancer and birth defects or other reproductive harm. For more information go to [www.p65warnings.ca.gov](http://www.p65warnings.ca.gov).

## Series WC S106WC Female JIC 37° – Straight Swivel

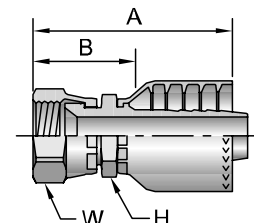

# Part Number	Hose ID (in)	Thread ID (in)	Thread Dash Size	Dimensions						Approx Wt Per Ctn (lbs)	Std Pack Qty (per carton)	Pkg Type
				A (in)	A (mm)	H (in)	W (in)	B (in)	B (mm)			
S106WC-32-32	2	2-1/2x12	-32	5.95	151	2-5/8	2-7/8	2.70	69	2.00	2	Carton

**Material:** Plated steel

**WARNING:** This product can expose you to chemicals including Lead, which is known to the State of California to cause cancer and birth defects or other reproductive harm. For more information go to [www.p65warnings.ca.gov](http://www.p65warnings.ca.gov).

### Crimp Specifications

For currently qualified crimp specifications including coupling designation, refer to CrimpSource at [www.parker.com/crimpsource](http://www.parker.com/crimpsource). Refer to the COS-K4 crimper for crimp specs for hose 4" ID and smaller. Refer to the COS-K6 or COS-K10 crimpers for hose IDs larger than 4".

## Series 7661/TY-FA Female SAE 45° – Straight Swivel

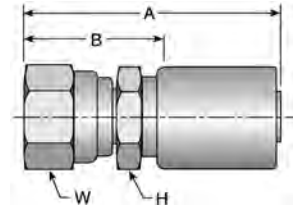

# Part Number	Hose ID (in)	Thread ID (in)	Thread Dash Size	Dimensions						Approx Wt Per Ctn (lbs)	Std Pack Qty (per carton)	Pkg Type
				A (in)	A (mm)	H (in)	W (in)	B (in)	B (mm)			
7661-06FA04TY	1/4	5/8x18	-6	2.72	69	11/16	3/4	1.38	35	2.20	20	Carton
7661-08FA08TY	1/2	3/4x16	-8	2.91	74	7/8	7/8	1.405	36	4.20	20	Carton
7661-10FA10TY	5/8	7/8x14	-10	3.06	78	1-1/8	1	1.69	43	6.20	20	Carton

**Material:** Plated steel

**WARNING:** This product can expose you to chemicals including Lead, which is known to the State of California to cause cancer and birth defects or other reproductive harm. For more information go to [www.p65warnings.ca.gov](http://www.p65warnings.ca.gov).

## Series 7661/TY-FF Female NPTF Pipe – Straight Rigid

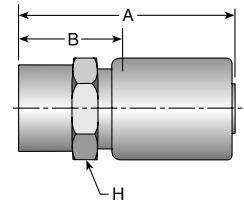

# Part Number	Hose ID (in)	Thread ID (in)	Thread Dash Size	Dimensions						Approx Wt Per Ctn (lbs)	Std Pack Qty (per carton)	Pkg Type
				A (in)	A (mm)	H (in)	B (in)	B (mm)				
7661-04FF04TY	1/4	1/4x18	-4	2.47	63	11/16	1.15	26	3.23	25	Carton	

**Material:** Plated steel

**WARNING:** This product can expose you to chemicals including Lead, which is known to the State of California to cause cancer and birth defects or other reproductive harm. For more information go to [www.p65warnings.ca.gov](http://www.p65warnings.ca.gov).

## Series 7661/TY-FJ Female JIC 37° – Straight Swivel

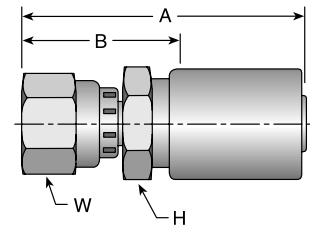

# Part Number	Hose ID (in)	Thread ID (in)	Thread Dash Size	Dimensions						Approx Wt Per Ctn (lbs)	Std Pack Qty (per carton)	Pkg Type
				A (in)	A (mm)	H (in)	W (in)	B (in)	B (mm)			
7661-04FJ04TY	1/4	7/16x20	-4	2.60	66	9/16	9/16	1.25	32	3.18	25	Carton
7661-08FJ08TY	1/2	3/4x16	-8	2.90	74	7/8	7/8	1.56	40	26.40	100	Carton
7661-10FJ08TY	1/2	7/8x14	-10	2.98	76	1	1	1.63	41	5.28	20	Carton

**Material:** Plated steel

**WARNING:** This product can expose you to chemicals including Lead, which is known to the State of California to cause cancer and birth defects or other reproductive harm. For more information go to [www.p65warnings.ca.gov](http://www.p65warnings.ca.gov).

### Crimp Specifications

For currently qualified crimp specifications including coupling designation, refer to CrimpSource at [www.parker.com/crimpsource](http://www.parker.com/crimpsource). Refer to the COS-K4 crimper for crimp specs for hose 4" ID and smaller. Refer to the COS-K6 or COS-K10 crimpers for hose IDs larger than 4".

## Series 7661/TY-MP Male NPTF Pipe – Straight Rigid

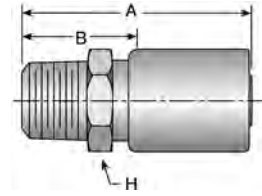

# Part Number	Hose ID (in)	Thread ID (in)	Thread Dash Size	Dimensions						Approx Wt Per Ctn (lbs)	Std Pack Qty (per carton)	Pkg Type
				A (in)	A (mm)	H (in)	B (in)	B (mm)				
7661-04MP04TY	1/4	1/4x18	-4	2.53	64	9/16	1.19	30	7.00	50	Carton	
7661-06MP08TY	1/2	3/8x18	-6	2.72	69	7/8	1.38	35	6.00	20	Carton	
7661-08MP08TY	1/2	1/2x14	-8	2.91	74	7/8	1.56	40	30.00	100	Carton	
7661-12MP08TY	1/2	3/4x14	-12	2.91	74	1-1/16	1.56	40	80.00	80	Carton	

**Material:** Plated steel

**WARNING:** This product can expose you to chemicals including Lead, which is known to the State of California to cause cancer and birth defects or other reproductive harm. For more information go to [www.p65warnings.ca.gov](http://www.p65warnings.ca.gov).

## Series 7661/TY-SP Male NPTF Pipe – Straight Swivel

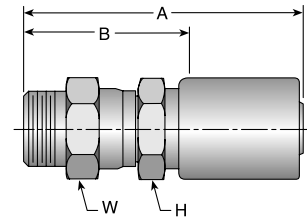

# Part Number	Hose ID (in)	Thread ID (in)	Thread Dash Size	Dimensions						Approx Wt Per Ctn (lbs)	Std Pack Qty (per carton)	Pkg Type
				A (in)	A (mm)	H (in)	W (in)	B (in)	B (mm)			
7661-08SP08TY	1/2	1/2x14	-8	3.50	89	7/8	7/8	2.16	55	34.20	100	Carton

**Material:** Plated steel

**WARNING:** This product can expose you to chemicals including Lead, which is known to the State of California to cause cancer and birth defects or other reproductive harm. For more information go to [www.p65warnings.ca.gov](http://www.p65warnings.ca.gov).

## Series 7661/LA-FJ Female JIC 37° – Straight Swivel

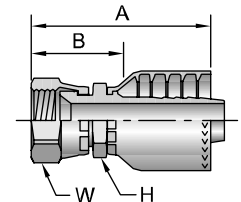

# Part Number	Hose ID (in)	Thread ID (in)	Thread Dash Size	Dimensions						Approx Wt Per Ctn (lbs)	Std Pack Qty (per carton)	Pkg Type
				A (in)	A (mm)	H (in)	W (in)	B (in)	B (mm)			
7661-32FJ32LA	2	2-1/2x12	-32	5.39	137	2-5/8	2-7/8	2.70	69	27.20	7	Carton

**Material:** Plated steel

**WARNING:** This product can expose you to chemicals including Lead, which is known to the State of California to cause cancer and birth defects or other reproductive harm. For more information go to [www.p65warnings.ca.gov](http://www.p65warnings.ca.gov).

### Crimp Specifications

For currently qualified crimp specifications including coupling designation, refer to CrimpSource at [www.parker.com/crimpsource](http://www.parker.com/crimpsource). Refer to the COS-K4 crimper for crimp specs for hose 4" ID and smaller. Refer to the COS-K6 or COS-K10 crimpers for hose IDs larger than 4".

## Series 7661/LA-NP Male NPTF Pipe – Straight Rigid

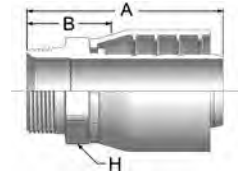

# Part Number	Hose ID (in)	Thread ID (in)	Thread Dash Size	Dimensions					Approx Wt Per Ctn (lbs)	Std Pack Qty (per carton)	Pkg Type
				A (in)	A (mm)	H (in)	B (in)	B (mm)			
7661-32NP32LA	2	2x11-1/2	-32	5.39	137	2-5/8	2.14	54	26.90	8	Carton

**Material:** Plated steel

**WARNING:** This product can expose you to chemicals including Lead, which is known to the State of California to cause cancer and birth defects or other reproductive harm. For more information go to [www.p65warnings.ca.gov](http://www.p65warnings.ca.gov).

## Series 7661/LAR-FJ Female JIC 37° – Straight Swivel with Internal O-Ring

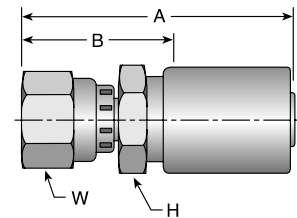

# Part Number	Hose ID (in)	Thread ID (in)	Thread Dash Size	Dimensions						Approx Wt Per Ctn (lbs)	Std Pack Qty (per carton)	Pkg Type
				A (in)	A (mm)	H (in)	W (in)	B (in)	B (mm)			
7661-16FJ16LAR	1	1-5/16x12	-16	3.55	90	1-3/8	1-3/8	1.81	46	17.15	25	Carton

**Material:** Plated steel

**WARNING:** This product can expose you to chemicals including Lead, which is known to the State of California to cause cancer and birth defects or other reproductive harm. For more information go to [www.p65warnings.ca.gov](http://www.p65warnings.ca.gov).

## Series 7661/LAR-MP Male NPTF Pipe – Straight Rigid with Internal O-Ring

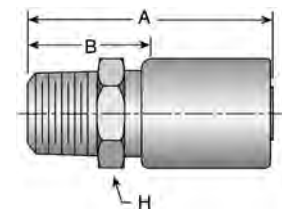

# Part Number	Hose ID (in)	Thread ID (in)	Thread Dash Size	Dimensions					Approx Wt Per Ctn (lbs)	Std Pack Qty (per carton)	Pkg Type
				A (in)	A (mm)	H (in)	B (in)	B (mm)			
7661-16MP16LAR	1	1x11-1/2	-16	3.42	87	1-3/8	1.69	43	15.73	25	Carton

**Material:** Plated steel

**WARNING:** This product can expose you to chemicals including Lead, which is known to the State of California to cause cancer and birth defects or other reproductive harm. For more information go to [www.p65warnings.ca.gov](http://www.p65warnings.ca.gov).

### Crimp Specifications

For currently qualified crimp specifications including coupling designation, refer to CrimpSource at [www.parker.com/crimpsource](http://www.parker.com/crimpsource). Refer to the COS-K4 crimper for crimp specs for hose 4" ID and smaller. Refer to the COS-K6 or COS-K10 crimpers for hose IDs larger than 4".

## Series CS

### S101CS Male NPTF Pipe – Straight Rigid

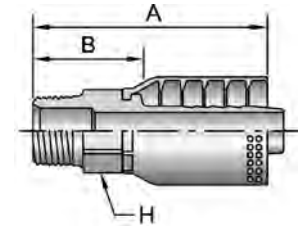

# Part Number	Hose ID (in)	Thread ID (in)	Thread Dash Size	Dimensions					Approx Wt Per Ctn (lbs)	Std Pack Qty (per carton)	Pkg Type
				A (in)	A (mm)	H (in)	B (in)	B (mm)			
S101CS-12-12	3/4	3/4x14	-12	3.56	90	1-1/8	1.75	44	16.05	25	Carton
S101CS-16-16	1	1x11-1/2	-16	3.94	100	1-3/8	2.00	51	27.43	25	Carton

**Material:** Plated steel

**WARNING:** This product can expose you to chemicals including Lead, which is known to the State of California to cause cancer and birth defects or other reproductive harm. For more information go to [www.p65warnings.ca.gov](http://www.p65warnings.ca.gov).

## Series 7610/CS

### Crimp Coupling for Steam Hose

#### Female Ground Joint NPSM with Wing Nut and O-Ring

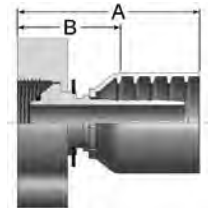

# Part Number	Description	Hose ID (in)	Thread (in)	Dimensions				Approx Wt Per Ctn (lbs)	Std Pack Qty (per carton)	Pkg Type
				A (in)	A (mm)	B (in)	B (mm)			
7610-12CSGJF	With Wing Nut	3/4	1-1/2	3.70	94	1.57	40	4.00	4	Carton
7610-12CSGJFS	Spud	3/4	1-1/2	n/a	n/a	n/a	n/a	4.00	4	Carton
7610-16CSGJF	With Wing Nut	1	1-1/2	3.97	100	1.53	39	4.00	4	Carton

**Material:** Coupling, plated steel; Wing Nut, malleable iron

**WARNING:** This product can expose you to chemicals including Lead, which is known to the State of California to cause cancer and birth defects or other reproductive harm. For more information go to [www.p65warnings.ca.gov](http://www.p65warnings.ca.gov).

## Series 7612

### Spud Adapter for Steam Hose

#### 3/4" Female Pipe Straight x 1-1/2" Ground Joint Male



# Part Number	Description	Approx Wt Per Ctn (lbs)	Std Pack Qty (per carton)	Pkg Type
7612-750GFS3	3/4" Female Pipe Straight to 1-1/2" Ground Joint Male	10.00	10	Carton

**Material:** Plated steel

**WARNING:** This product can expose you to chemicals including Lead, which is known to the State of California to cause cancer and birth defects or other reproductive harm. For more information go to [www.p65warnings.ca.gov](http://www.p65warnings.ca.gov).

#### Crimp Specifications

For currently qualified crimp specifications including coupling designation, refer to CrimpSource at [www.parker.com/crimpsource](http://www.parker.com/crimpsource). Refer to the COS-K4 crimper for crimp specs for hose 4" ID and smaller. Refer to the COS-K6 or COS-K10 crimpers for hose IDs larger than 4".

## Series 20

### Reattachable Couplings for LPG Fuel Hose

#### Female SAE 45° – Straight Swivel

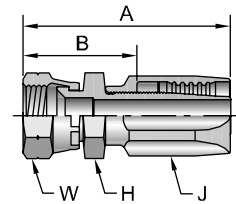

# Part Number	Hose ID (in)	Thread ID (in)	Thread Dash Size	Dimensions							Approx Wt Per Ctn (lbs)	Std Pack Qty (per carton)	Pkg Type
				A (in)	A (mm)	H (in)	J (in)	W (in)	B (in)	B (mm)			
S20820-6-6	5/16	5/8x18	-6	2.36	60	3/4	13/16	3/4	1.44	37	4.20	25	Carton

**Material:** Plated steel

**WARNING:** This product can expose you to chemicals including Lead, which is known to the State of California to cause cancer and birth defects or other reproductive harm. For more information go to [www.p65warnings.ca.gov](http://www.p65warnings.ca.gov).

## Series CGHBL

### Stem for Welding Hose

**NOTE:** Use D Nuts

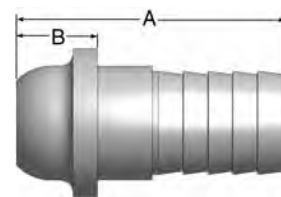

# Part Number	Hose ID (in)	Dimensions				Approx Wt Per Each (lbs)	Std Pack Qty (per carton)	Pkg Type
		A (in)	A (mm)	B (in)	B (mm)			
CGHBL-12-12	3/4	2.26	57	0.62	16	0.50	Per Order	Carton

**Material:** Brass

## Series HBL-C

### Male BSPP w/Seal – Straight Rigid

#### For Series 7116M DEF Hose

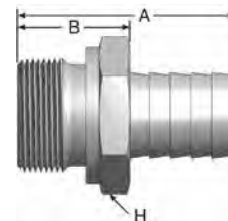

# Part Number	Hose ID (in)	Thread ID (in)	Thread Dash Size	Dimensions					Approx Wt Per Ctn (lbs)	Std Pack Qty (per carton)	Pkg Type
				A (in)	A (mm)	H (in)	B (in)	B (mm)			
S1D00NMHBL-12-12C	3/4	3/4x14	-12	2.00	51	1-1/4	1.03	26	4.36	25	Carton

**Material:** 304 stainless steel

**NOTE:** Requires SMCP24631 or SMCP24633 ferrules.

**WARNING:** This product can expose you to chemicals including Lead, which is known to the State of California to cause cancer and birth defects or other reproductive harm. For more information go to [www.p65warnings.ca.gov](http://www.p65warnings.ca.gov).

#### Crimp Specifications

For currently qualified crimp specifications including coupling designation, refer to CrimpSource at [www.parker.com/crimpsource](http://www.parker.com/crimpsource). Refer to the COS-K4 crimper for crimp specs for hose 4" ID and smaller. Refer to the COS-K6 or COS-K10 crimpers for hose IDs larger than 4".

# Series HBL-C

## Male NPTF Pipe – Straight Rigid

### For Series 7116M DEF Hose

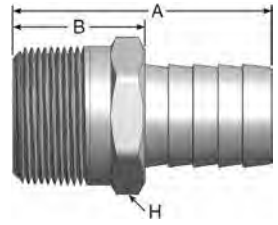

# Part Number	Hose ID (in)	Thread ID (in)	Thread Dash Size	Dimensions					Approx Wt Per Ctn (lbs)	Std Pack Qty (per carton)	Pkg Type
				A (in)	A (mm)	H (in)	B (in)	B (mm)			
S125HBL-12-12C	3/4	3/4x14	-12	1.98	50	1-1/16	1.01	26	4.36	25	Carton

**Material:** 304 stainless steel

**NOTE:** Requires SMCP24631 or SMCP24633 ferrules.

**WARNING:** This product can expose you to chemicals including Lead, which is known to the State of California to cause cancer and birth defects or other reproductive harm. For more information go to [www.p65warnings.ca.gov](http://www.p65warnings.ca.gov).

# Series SMCP

## Ferrule



# Part Number	Hose Series	Hose ID (in)	Ferrule Lg (in)	Ferrule ID (in)	Ferrule ID (mm)	Approx Wt Per Ctn (lbs)	Std Pack Qty (per carton)	Pkg Type
SMCP24633	7116M	3/4	1.200	0.843	21.4	2.50	25	Carton

**Material:** Nickel plated brass

**WARNING:** This product can expose you to chemicals including Titanium Dioxide, which is known to the State of California to cause cancer. For more information go to [www.p65warnings.ca.gov](http://www.p65warnings.ca.gov).

### Crimp Specifications

For currently qualified crimp specifications including coupling designation, refer to CrimpSource at [www.parker.com/crimpsource](http://www.parker.com/crimpsource). Refer to the COS-K4 crimper for crimp specs for hose 4" ID and smaller. Refer to the COS-K6 or COS-K10 crimpers for hose IDs larger than 4".



# Parker Fluid Connectors Group

## North American Divisions & Distribution Service Centers

**Your complete source** for quality tube fittings, hose & hose fittings, brass & composite fittings, quick-disconnect couplings, valves and assembly tools, locally available from a worldwide network of authorized distributors.

### **Fittings:**

Available in inch and metric sizes covering SAE, BSP, DIN, GAZ, JIS and ISO thread configurations, manufactured from steel, stainless steel, brass, aluminum, nylon and thermoplastic.

### **Hose, Tubing and Bundles:**

Available in a wide variety of sizes and materials including rubber, wire-reinforced, thermoplastic, hybrid and custom compounds.

### **Worldwide Availability:**

Parker operates Fluid Connectors manufacturing locations and sales offices throughout North America, South America, Europe and Asia-Pacific.

**For information,** call toll free...

**1-800-C-PARKER**  
**(1-800-272-7537)**

## **North American Divisions**

### **Fluid System Connectors Division**

Otsego, MI  
phone 269 694 9411  
fax 269 694 4614

### **Hose Products Division**

Wickliffe, OH  
phone 440 943 5700  
fax 440 943 3129

### **Parflex Division**

Ravenna, OH  
phone 330 296 2871  
fax 330 296 8433

### **Quick Coupling Division**

Minneapolis, MN  
phone 763 544 7781  
fax 763 544 3418

### **Tube Fittings Division**

Columbus, OH  
phone 614 279 7070  
fax 614 279 7685

## **Distribution Service Centers**

### **Buena Park, CA**

phone 714 522 8840  
fax 714 994 1183

### **Conyers, GA**

phone 770 929 0330  
fax 770 929 0230

### **Louisville, KY**

phone 502 937 1322  
fax 502 937 4180

### **Portland, OR**

phone 503 283 1020  
fax 503 283 2201

### **Toledo, OH**

phone 419 878 7000  
fax 419 878 7001  
fax 419 878 7420  
(FCG Kit Operations)

### **Canada**

#### **Milton, ONT**

phone 905 693 3000  
fax 905 876 1958  
(Contact Milton for other Service Center locations.)

### **Mexico**

#### **Toluca, MEX**

phone (52) 722 2754 200  
fax (52) 722 2722 168



Parker Hannifin Corporation

### **Hose Products Division**

30240 Lakeland Boulevard  
Wickliffe, OH 44092

Customer Service:

Toll Free 866 810 HOSE (4673)  
email [indhose@parker.com](mailto:indhose@parker.com)  
[www.parker.com/hpd](http://www.parker.com/hpd)